



INSTITUT FÜR OSTSEEFISCHEREI

Alter Hafen Süd 2, 18069 Rostock Telefon 0381 8116122 Telefax 0381 8116-199 juan.santos@thuenen.de

Report

Of the Cruise N° 739, by the FRV Solea
from 12.09 to 28.09.2017

Cruise leaders Juan Santos & Dr. Daniel Stepputtis

Research partners: Pieke Molenaar & Jimmy van Rijn (Wageningen Marine Research, Netherlands)

Summary

Two innovative grid systems were experimentally tested in the North Sea- brown shrimp fishery. The systems were proposed to supplement codend selectivity, as a strategy to reduce the wide selection ranges provided by standard gears. Results show promising results of the concepts tested, as the selection ranges obtained with both grid systems were significantly lower than those obtained with any of the codends tested during the CRANNET project. However, the concepts tested here require further development before being considered for commercial use.

Verteiler:

BLE, Hamburg
Schiffsführung FFS SOLEA
BMEL, Ref. 614
Deutsche Fischfang-Union Cuxhaven
Sassnitzer Seefischerei e. G.
Landesverband der Kutter- u.
Kustenfischer
DFFU Cuxhaven
Thünen Institut Präsidialbüro (Dr.
Welling)
Thünen Institut Verwaltung Hamburg
Thünen Institut FIZ
Thünen Institut für Fischereiökologie
Thünen Institut für Seefischerei
Thünen Institut für Ostseefischerei

BFEL HH, FB Fischqualität
Reiseplanung Forschungsschiffe, Herr Dr. Rohlf
Fahrtteilnehmer
Bundesamt für Seeschifffahrt und Hydrographie, Hamburg
Mecklenburger Hochseefischerei Sassnitz
Doggerbank Seefischerei GmbH, Bremerhaven
Deutscher Fischerei-Verband e. V., Hamburg
Leibniz-Institut für Meereswissenschaften IFM-GEOMAR
BSH, Hamburg
Leibniz-Institut für Ostseeforschung Warnemünde
Institut für Fischerei der Landesforschungsanstalt
LA für Landwirtschaft, Lebensmittels. Und Fischerei
Euro-Baltic Mukran
Fahrtteilnehmer

Contents

1	Introduction	1
2	Material and Methods	2
2.1	Target fishery	2
2.2	Research vessel, trawls and experimental grid gears	2
2.2.1	Single-grid gear	3
2.2.2	Multi-grid gear	4
2.3	Experimental design and data collection	6
2.4	Analysis of sorting efficiency	8
2.4.1	Model for sorting efficiency of Single-grid gear	8
2.4.2	Model for sorting efficiency of Multi-grid gear	9
2.4.3	Fishery Selectivity Indicators	10
2.5	Underwater video recordings	10
3	Results	10
3.1	Development phase	14
3.1.1	Single-grid gear	14
3.1.2	Multi-grid gear	17
3.2	Analysis of sorting efficiency	19
3.2.1	Single-grid SG5	19
3.2.2	Multi-grid MG3	21
3.3	Underwater video recordings	21
4	Final remarks	24
5	Research crew members	25
6	Financial contributions	25
7	Acknowledgments	25

1 Introduction

The brown shrimp (*Crangon crangon*) beam-trawl fishery supports an international fleet of more than 500 vessels, producing yearly revenues of up to 100 million Euro [2]. Landings are consistently larger than 30,000 tonnes in recent years, with Dutch and German fleets in the length category between 10 and 30 m making up approximately 90% of the total landings. Despite being one of the most important fisheries in the North Sea [4], the brown shrimp fishery is one of the less regulated fisheries in European waters [9], as fishing activities are not subjected to quotas or other restrictions, except market-induced minimum landing sizes. The lack of incentives coming from the management of the fishery (reference points) explain the low effort invested historically in the search for technical solutions to reduce the by-catch of small brown shrimps.

In recent times, brown shrimp producer organizations went through a certification process by the Marine Stewardship Council (MSC). One of the key aspects for successful certification was the need to find alternative gear technologies to improve exploitation patterns of the targeted shrimp [2, 6]. The little information available regarding the selectivity of commercial gears motivated the German project CRANNET [3, 8], conducted between 2013 and 2015 with the aim of providing scientifically-based advice on which codend designs should be used in the fishery to better exploit the population. CRANNET involved the collection and analysis of a large selectivity dataset, based on more than 200 beam-trawl hauls conducted during four experimental fishing cruises, using 33 different codend designs varying in mesh size and mesh type (diamond-mesh, square-mesh and T90). Such information was used within the project to establish a predictive framework for brown shrimp selectivity. The framework was applied in conjunction with population dynamic tools to explore obtainable exploitation patterns depending on codend design. Predictions confirmed preliminary concerns regarding the current exploitation patterns of the fishery, due to the high catch efficiency of the commercial codends on undersized shrimps ($> 90\%$). Such a high retention rate could be reduced to $\sim 50\%$ by increasing codend mesh size from the current 20-22mm to 25-29 mm, depending on codend mesh type.

Although the project delivered clear recommendations on which codend designs should be used in the fishery, theoretical simulations showed that achieving sharper selectivity curves than those provided by codends might be of great benefit in terms of economical revenues for the fishermen and the sustainability of the fishery. This theoretical-based advice motivated the first research topic of the current cruise S0739. Two innovative grid concepts proposed, designed and built by a Dutch Netmaker were tested for first time onboard the Fishing Research Vessel *SOLEA*, as technological alternatives to achieve sharper size selectivity of brown shrimp. The main aim was to conduct a first assessment of the practicality, mechanical behaviour, and performance of the initial designs brought onboard, and to develop them until achieving reasonable performances enabling investigations of their size selectivity properties.

This is a joint research topic involving researchers from the Thünen Institute (Germany), Wageningen Marine Research Institute (Netherlands) and the Dutch Industry (Visserijbedrijf Van Eekelen).

The present cruise was also used to replicate the pulse trawl experiments conducted in the previous cruise S0732 (March 2017). Such experiments were designed to investigate if reduced pulse parameters (pulse duration and number of pulses) could be as efficient to catch brown shrimp as standard pulse parameters. Results of this experiment are not presented here, since the data collected was still being processed at the time the report was writing.

2 Material and Methods

2.1 Target fishery

The North Sea-brown shrimp fishery is mainly occurring in the shallow coastal waters, being active all year-round. Most exploited fishing grounds are located in the Danish, German and Dutch Waddensea, and, to a lesser extent, also in coastal waters of Belgium, France and the UK. Average vessels are 24 meter-long, and powered with up to 224kW engines. Smaller vessels usually land their catches daily, while larger vessels usually conduct 4 – 5 day trips, being reduced to 2.5 day-trips to keep catch quality in the summer season.

Vessels are rigged with a small-mesh, ~ 9 -meter length beam trawl per side. Cod-end mesh sizes range between 16 and 26mm, being 22mm the most frequent size applied. The duration of the fishing hauls may be up to 2 hours, but depending on catch quantity and composition haul durations between 60 and 90 minutes are common. Catch quantity and composition are highly variable and dependent on fishing location and season. In particular protected areas (e.g. Waddensea) it is seasonal or year-round compulsory to have mounted a bycatch reduction device for fish species in the trawl. This device generally is a sieve net [7] with 50 to 70mm mesh openings directing all larger fish/crustaceans to an escape hole in the bottom of the trawl. Age-0 fish and small crustaceans including the brown shrimp pass through the sieve net, ending in the codend where the size selection takes place. Relatively large bycatch amounts can occur, made up of undersized shrimps, age-0 fish and Benthic invertebrates. Once the catch is hauled on deck, catches are sorted by rotating and shaking sieves. The sieves usually have a bar spacing of ~ 6 mm, which should effectively separate marketable shrimps of ~ 55 mm (total length) from the bycatch fraction. After the mechanical sorting of the catch, unwanted bycatch is discarded while the marketable shrimps are cooked in seawater, packed and stored. Discard rates of the fishery vary significantly among fishing grounds and seasons, with percentages ranging from ~ 20 up to $\sim 90\%$ relative to the total catch.

2.2 Research vessel, trawls and experimental grid gears

Experiment described below were conducted onboard *FRV/SOLEA*, a 42m, 1780kW multi-purpose vessel designed for investigations on middle-water fisheries such as those in the Baltic Sea and the North Sea.

Two different types of trawls were used. The vessel mounted its own beam trawls during the first part of the cruise. The SOLEA-beam trawls are made of PA 210/48 – 24, with mesh sizes (inner mesh size from knot-to-knot) ranging from 30mm in the fore part to 20mm at the connection with the codend. The mouth of the trawl is defined by a 9.5m long, 14mm-PES groundrope, and 6.85m -PP headline 18mm thick. Since the original sieve nets of the trawls were not available for the cruise, two alternative sieve nets were constructed *ad hoc* using 70mm nominal mesh size netting available onboard.

The SOLEA-beam trawls were replaced by two 7m pulse trawls for the second part of the cruise. The sieve nets attached to the pulse trawls were made of 57mm diamond-mesh size.

The standard codends of the trawls were replaced by experimental extensions mounting the grid systems and covers. The experimental gears were designed by Kees van Eekelen, a Dutch netmaker and former fisher, who also developed the SepNep trawl for Nephrops fisheries [1]. Grids were made of plastic with 6mm bar spacing, same space as used on deck sieving machines to sort undersized from marketable shrimp. The two different grid

systems are described in the following subsections.

2.2.1 Single-grid gear

Conceptually similar to other well-know grid concepts such as the Swedish grid used in Nephrops fisheries [10], this grid is made of 21 plastic bars 20mm thick and 6mm bar-spacing. The grid was inserted in a steel frame with the bars vertically oriented and with an inclination of $\sim 45^\circ$. Further constructive details of the grid can be found in Figure 1. The grid was mounted in a extension piece made of 20mm diamond-mesh netting. A oblique net panel placed in front of the grid was used to guide fish and invertebrates towards the lower part of the grid (Figure 2). The extension piece of net including the plastic grid and guiding panel was initially mounted to the port-side trawl.

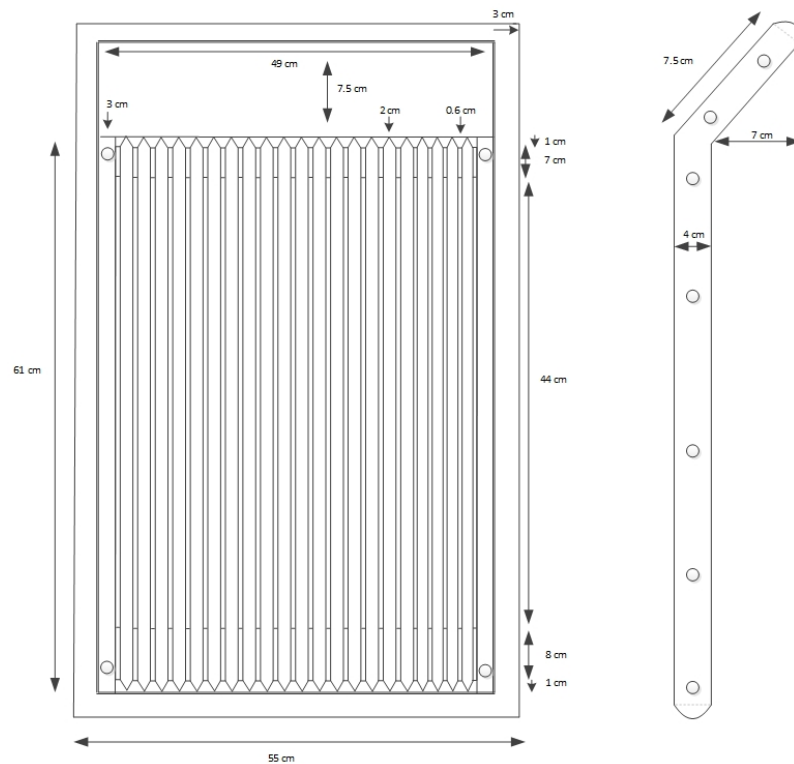

Figure 1: Constructive details of the single grid

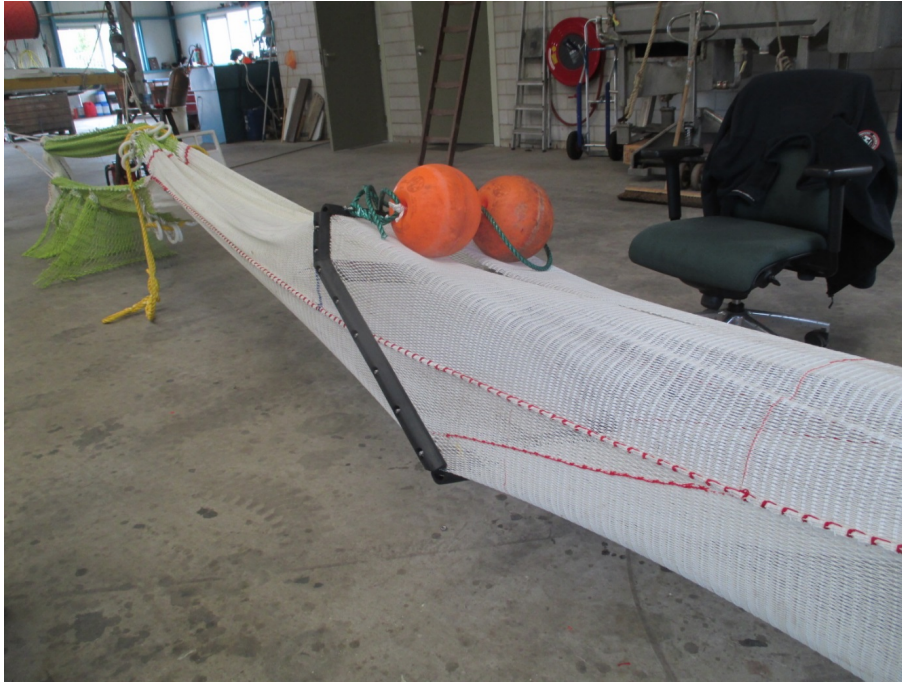

Figure 2: Single-grid gear under construction in the net loft. The oblique red selvedge is the connection of the guiding panel to the net tunnel.

2.2.2 Multi-grid gear

The second concept developed and tested during the cruise consisted of four small plastic grids inserted alternatively in the upper and the bottom of an extension piece 20mm mesh size. The space between grid bars was the same as for the single grid (6mm). With the specific positioning of the grids in the extension, it was intended for fish and invertebrates entering the extension to follow a Zigzag path towards the codend. This special configuration aimed to maximize the probability for shrimps to contact the grids (Figures 3,4 and 5).

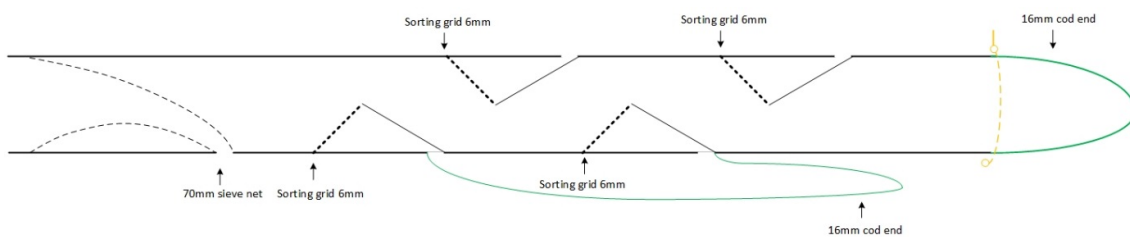

Figure 3: Side view of the Multi-grid gear.

Both the Single- and the Multi-grid gears described above were tested for first time in the present cruise, without any prior information regarding how the gears should be rigged to ensure a proper functioning. Therefore a significant effort was invested in addressing mechanical problems observed during fishing.



Figure 4: Multi-grid gear under construction in the net loft.



Figure 5: Multi-grid gear during experimental fishing.

2.3 Experimental design and data collection

Catch data collected at haul level should be used to quantify sorting efficiency of brown shrimp by each of the gears tested. Therefore it was of priority interest to collect in different compartments i) brown shrimp individuals passing through the grids (escapees), and ii) individuals directed to the codend, either because they did not effectively contacted the grid, or because they were retained by the grids due to size selection after contact. An experimental design based on covers [11] was applied to obtain direct observations of the shrimps either able to escape or retained by the grids. Three different type of covers made of 16mm diamond-mesh size were used:

- Escape covers (EC): Fitted to the escaping area of a grid to collect those shrimps passing through the spaces between bars.
- Grid cover (GC): Fitted to the upper outlet of the single grid (Figure 1), to collect either those shrimps not contacting the grid area or those retained by the grid by means of size selection.
- Blind codend (BC): Only used for the multi-grid gear to collect all shrimps not escaping through the grids.

The covers itemized above were used two define the experimental compartments in both gears. A Two compartment setup was considered for the Single-grid, using an EC to collect escapees, and a GC to collect retained shrimps. A three compartment setup was considered for the Multi-grid gear, by mounting two EC to collect escapees from the lower and upper grids independently, and a BC in the aft of the gear. Catches were collected for each trawl separately, and no between-gears comparisons were considered in this study.

Catches from each experimental compartment were emptied separately into large tubs, and weighed to determine the total catch. Once weighted, the catch was randomly spread out on the conveyor belt in the wet lab. When the catch was too large, a sample was randomly collected. The total catch (or the representative sample) was subsequently sorted by species (Figure 6). Three different sampling protocols were established at this stage:

- Fish species: Total catch weight was firstly collected for each species, followed by individual length-measurements. In case of a large number of individuals, only a fraction of the total number was length-measured and weighted as sub-sample.
- Brown shrimp: The total catch weight of brown shrimp was recorded. A subsample of $\sim 1kg$ was collected from the catch and stored in a freezer for later length measurements in dry lab.
- Other invertebrates: The total weight and the number of individuals caught were collected. In case of a large number of individuals, only a fraction was counted and weighted as sub-sample.

Fish were length-measured with half-centimetre precision using electronic scales ScantrolTM (models FM50 and FM100). Weights were taken using MarelecTM marine scales. Shrimp length measurements were done in Wageningen Marine Research Institute (Netherlands) after the cruise, using an electronic tablet in conjunction with the software **Garnelenmessung** designed by the Thuenen institute (Figure 6).

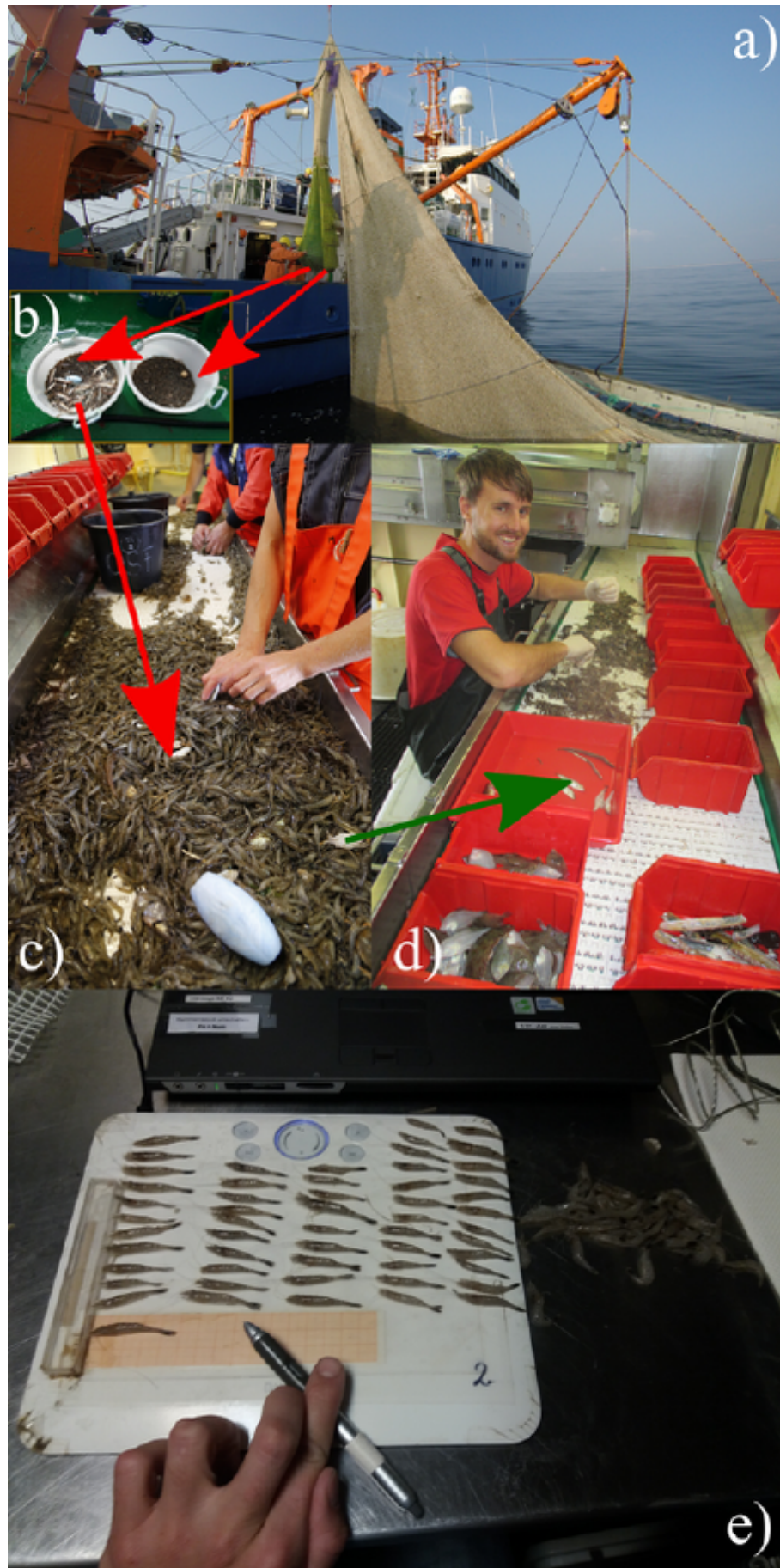

Figure 6: Different stages of the sampling protocol. Catches from each gear compartment are collected separately in large tubs (a-b). Catch of a given compartment is spilled on the conveyor belt (c) After recording the catch weight. Catch is sorted by species separation and the data collection by-species is initiated (d). Picture (e) shows the tablet used for brown shrimp measurements.

2.4 Analysis of sorting efficiency

2.4.1 Model for sorting efficiency of Single-grid gear

Number of fish observed in GC ($n_{l,GC}$) and EC ($n_{l,EC}$) depends on the probability for the length l to pass through the grid once it enters in the grid zone:

$$\begin{aligned} n_{l,GC} &= N_l \times (1 - p(l)) \\ n_{l,EC} &= N_l \times p(l) \end{aligned} \quad (1)$$

of

In Equation 1, N_l is the total number of shrimps of length l entering in the zone where the grid is mounted, while $p(l)$ is the probability for the length l to pass the grid. $p(l)$ was defined as it follows:

$$p(C, l, L50, SR) = C \times (1 - r(l, L50, SR)) \quad (2)$$

In Equation 2, the parameter C denotes the length-independent probability for a individual to efficiently contact the grid becoming available for size selection. $r(l)$ is the contact size selection properties of the grid. To model $r(l)$, four standards functions (*logit*, *probit*, *Gompertz* and *Richards*) used to describe size selectivity in trawl gears [11] were considered as candidates. The best candidate in terms of AIC was selected. The size selection curve provided by $r(l)$ in Equation 2 is defined by two parameters; $L50$ is the length of brown shrimp with 50% probability of being retained by the grid, and SR , the range between the lengths with 75% and 25% retention probabilities. Parameters $C, L50$ and SR were estimated by maximizing the following likelihood function:

$$- \sum_l \sum_i (n_{l,EC} \times \log(p(C, l, L50, SR)) + n_{l,GC} \times \log(1.0 - p(C, l, L50, SR))) \quad (3)$$

Sorting efficiency of the gear is estimated by simple derivation of Equation 2:

$$R(C, l, L50, SR) = 1 - p(C, l, L50, SR) \quad (4)$$

Where the sums are for hauls i and length classes l . Evaluation of a models ability to describe the data sufficiently well using Equation 3 was based on the calculation of the corresponding p-value together with the visual inspection of residuals distribution. See [11] for details on how to apply these fit statistics.

Figure 7 represented the expected transportation paths for brown shrimps across the Single-grid gear

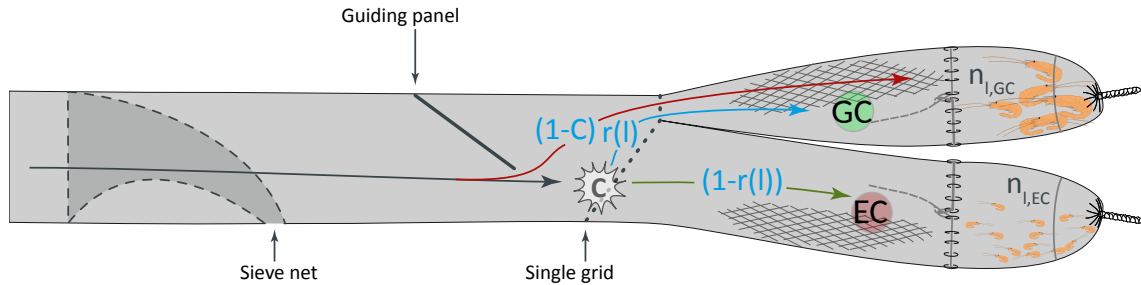

Figure 7: Expected transportation paths for brown shrimps entering in the grid zone, defining the catch share between GC ($n_{l,GC}$) and EC ($n_{l,EC}$)

2.4.2 Model for sorting efficiency of Multi-grid gear

The Multi-grid gear establishes four different escapement zones for brown shrimp before entering the codend (two lower grids and two upper grids). Collecting the escapees from each grid would require the use of four independent EC's. Considering also the BC mounted in this gear, such setup would lead to five compartments to be sampled independently from each other. To simplify the sampling scheme, the number of compartments was reduced to three, by collecting the escapees from the grids on each zone (bottom and top) aggregated. This lead to the following probability functions:

$$\begin{aligned} n_{l,low} &= N_l \times p_{low}(l) \\ n_{l,up} &= N_l \times p_{up}(l) \\ n_{l,bc} &= N_l \times (1 - p_{low}(l) - p_{up}(l)) \end{aligned} \quad (5)$$

In Equation 5, N_l is the total number of shrimps of length l entering in the gear, $p_{low}(l)$ is the probability for the length l to escape through any of the lower grids, and $n_{l,low}$ is the number of shrimps observed in the lower EC. $p_{up}(l)$ is the probability for the length l to escape through any of the upper grids, while $n_{l,up}$ is the number of shrimps observed in the upper EC. Finally, $n_{l,bc}$ is the number of shrimps not passing through any of the grids, ending in BC. Length-dependent probabilities $p_{low}(l)$ and $p_{up}(l)$ are modelled in the same way as in the case of the Single-grid gear:

$$\begin{aligned} p_{low}(C_{low}, l, L50, SR) &= C_{low} \times (1 - r(l, L50, SR)) \\ p_{up}(C_{up}, l, L50, SR) &= C_{up} \times (1 - r(l, L50, SR)) \end{aligned} \quad (6)$$

In Equation 6, C_{low} quantifies the contact probability of brown shrimps to the lower grids, while C_{up} is the contact probability associated to the upper grids. Since (upper and lower) grids share the same design, bar-spacing, and montage, in Equation 6 it is assumed same selectivity properties for all of them, being modelled using the *logit* function.

Parameters $C_{low}, C_{up}, L50, SR$ were estimated by maximizing the following likelihood function:

$$\begin{aligned} & - \sum_l \sum_i (n_{l,i,low} \times \log(p_{low}(C_{low}, l, L50, SR)) + n_{l,i,up} \times \log(p_{up}(C_{up}, l, L50, SR)) + \\ & + n_{l,i,bc} \times \log(1.0 - p_{low}(C_{low}, l, L50, SR) - p_{up}(C_{up}, l, L50, SR))) \end{aligned} \quad (7)$$

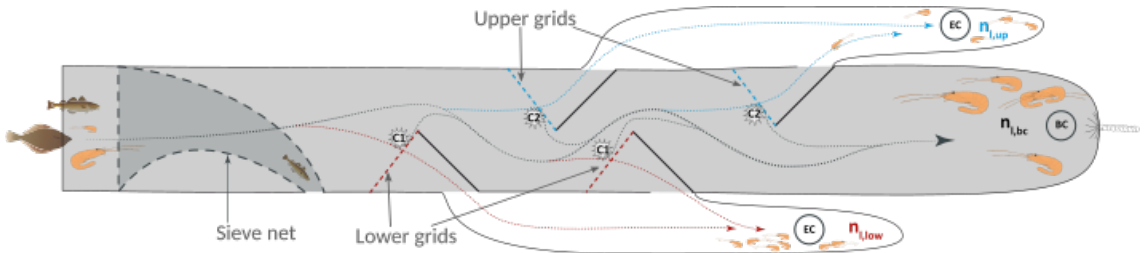

Figure 8: Expected transportation paths for brown shrimps entering in the grid zone, defining the catch share between the lower EC ($n_{l,low}$), upper EC ($n_{l,up}$) and BC ($n_{l,bc}$)

2.4.3 Fishery Selectivity Indicators

Besides the models described in the two previous sub-sections, The following Fishery Selectivity Indicators (FIS) were estimated for each compartment:

$$\begin{aligned}
 FIS_a &= 100 \times \frac{\sum_{l \geq ref} \sum_i (n_{l,i,M})}{\sum_{l \geq ref} \sum_i (n_{l,i,+})} \\
 FIS_b &= 100 \times \frac{\sum_{l < ref} \sum_i (n_{l,i,M})}{\sum_{l < ref} \sum_i (n_{l,i,+})} \\
 FIS_t &= 100 \times \frac{\sum_l \sum_i (n_{l,i,M})}{\sum_l \sum_i (n_{l,i,+})} \\
 nR &= 100 \times \frac{\sum_{l < ref} \sum_i (n_{l,i,M})}{\sum_{l \geq ref} \sum_i (n_{l,i,M})}
 \end{aligned} \tag{8}$$

Where $mls = 50mm$, considered an approximative species minimum landing size for local markets [5]. In Equation 8, the indicator FIS_a can be interpreted as the proportion (in percentage terms) of marketable brown shrimp observed in the compartment M relative to the total catch (+), FIS_b refers to the proportion of undersized brown shrimp observed in the same compartment M relative to the total catch, and FIS_t is the proportion of the total catch of brown shrimp caught by the gear observed in the compartment M . Finally, nR is the bycatch ratio indicator for compartment M .

The 95% Confidence Limits (CL) of models estimates from Equation 4 and Equation 7, and Fishery Selectivity Indicators (Equation 8) were estimated by the same bootstrap scheme used in the data analysis of the SO725 cruise. Further details can be found in [1].

2.5 Underwater video recordings

Besides the quantitative catch data, UWR were collected using at least one fishing haul per day. Different camera positions were defined, with the aim of collecting valuable information about the target / by-catch species behaviour in relation to the selection devices tested. Wide angle, self recording cameras (GoProTMHero3/Hero4TM) were used, and mounted in standard issue underwater housing. The camera system was mounted on a PVC plate with a stainless steel frame to protect it from the forces in the net. Heavy duty cable ties were used to secure the GoProTM in the underwater housing and the protective frame to the net.

3 Results

The cruise started on the morning of September 12. A starting haul was conducted the same day of departure in the fishing grounds of Helgolaender Bucht to check the behavior of the gears. The vessel proceed immediately after the haul to the port of Heligoland to take shelter from an approaching storm. The vessel stayed in the port for two days, time used to built the two sieve nets needed for the beam trawls (See section 2.2). The vessel went back to sea in the morning of September 15 to re-start the trials. A total of 7 additional hauls were conducted before completing the first half of the cruise. Large amounts of swimming crabs were found in the catches, probably due to inadequate mesh size used in the construction of the sieve nets. The large amounts of bycatch made the species sorting particularly difficult. In addition, considerable amounts of catch accumulated in front of the grids, potentially reducing their effectiveness and/or masking their selectivity properties. Due to these problems, the hauls conducted during the first part of the cruise were mostly used to gather information regarding mechanical behaviour of the

gears, required to improve the starting prototypes into functioning designs.

The vessel went to harbour on September 17 to replace the beam trawls by the pulse trawls. Both grid systems were alternatively mounted in the pulse trawl at port side to continue with the testing. Pulse trawls mounted sieve net with smaller mesh sizes (*57mm* vs the *70mm* sieve nets made onboard for the beam trawls), which reduced significantly the entry of unwanted species (e.g. crabs, starfish and fish) into the grids zone. Hauls conducted during the second part of the cruise are showed in Table 1.

Results are divided in three different sub-sections. The first sub-section is related to the development of the different designs tested during the cruise. A short description, the changes applied and their motivation is provided for each of the designs established. The second sub-section show the estimated sorting efficiency of two selected designs (one single-grid design and one multi-grid design), modelled using the tools described in Section 2.4.2 . The last sub-section describes briefly the collection of underwater video recordings.

Station	Haul	Haul Day	Date	Gear	Lot	Pulse Duration	Amplitude	Electrode Length	Lot	Pulse Duration	Amplitude	Electrode Length	Comments
606/12	9	1	17/09/2017 15:30	NA	2	0,5	60	1,2	1	0,5	60	1,2	
607/13	10	1	18/09/2017 7:00	NA	2	0,5	60	1,2	1	0,5	60	1,2	
608/14	11	2	18/09/2017 8:00	NA	2	0,5	60	1,2	1	0,5	60	1,2	
609/15	12	3	18/09/2017 9:17	NA	2	0,5	60	1,2	1	0,5	60	1,2	
610/16	13	4	18/09/2017 10:26	NA	2	0,5	60	1,2	1	0,5	60	1,2	
611/17	14	5	18/09/2017 11:33	NA	2	0,5	60	1,2	1	0,5	60	1,2	
612/18	15	6	18/09/2017 12:42	NA	2	0,5	60	1,2	1	0,5	60	1,2	
613/19	16	7	18/09/2017 13:54	NA	2	0,5	60	1,2	1	0,5	60	1,2	
614/20	17	8	18/09/2017 15:02	NA	2	0,5	60	1,2	1	0,5	60	1,2	
615/21	18	9	18/09/2017 16:10	NA	2	0,5	60	1,2	1	0,5	60	1,2	
616/22	19	1	19/09/2017 6:50	NA	2	0,5	60	1,2	1	0,1	60	1,2	
617/23	20	2	19/09/2017 7:55	NA	2	0,1	60	1,2	1	0,5	60	1,2	
618/24	21	3	19/09/2017 9:05	NA	2	0,5	60	1,2	1	0,1	60	1,2	No Catches
619/25	22	4	19/09/2017 10:10	NA	2	0,1	60	1,2	1	0,5	60	1,2	
620/26	23	5	19/09/2017 11:20	NA	2	0,5	60	1,2	1	0,1	60	1,2	No Catches
621/27	24	6	19/09/2017 12:25	NA	2	0,1	60	1,2	1	0,5	60	1,2	No Catches
622/28	25	7	19/09/2017 13:30	NA	2	0,5	60	1,2	1	0,1	60	1,2	No Catches
623/29	26	8	19/09/2017 14:35	NA	2	0,5	60	1,2	1	0,1	60	1,2	No Catches
624/30	27	9	19/09/2017 15:45	NA	2	0,5	60	1,2	1	0,1	60	1,2	
625/31	28	1	20/09/2017 6:50	NA	2	0,5	60	1,2	1	0,1	60	1,2	
626/32	29	2	20/09/2017 8:00	NA	2	0,1	60	1,2	1	0,5	60	1,2	Crabs
627/33	30	3	20/09/2017 9:10	NA	2	0,5	60	1,2	1	0,3	60	1,2	
628/34	31	4	20/09/2017 10:25	NA	2	0,3	60	1,2	1	0,5	60	1,2	
629/35	32	5	20/09/2017 11:35	NA	2	0,5	60	1,2	1	0,3	60	1,2	
630/36	33	6	20/09/2017 12:40	NA	2	0,3	60	1,2	1	0,5	60	1,2	
631/37	34	7	20/09/2017 13:50	NA	2	0,5	60	1,2	1	0,3	60	1,2	
632/38	35	8	20/09/2017 14:55	NA	2	0,3	60	1,2	1	0,5	60	1,2	
633/39	36	9	20/09/2017 16:00	NA	2	0,5	60	1,2	1	0,3	60	1,2	
634/40	37	1	21/09/2017 7:00	NA	2	0,3	60	1,2	1	0,5	60	1,2	
635/41	38	2	21/09/2017 8:05	NA	2	0,5	60	1,2	1	0,3	60	1,2	
636/42	39	3	21/09/2017 9:20	NA	2	0,1	60	1,2	1	0,5	60	1,2	
637/43	40	4	21/09/2017 10:30	NA	2	0,5	60	1,2	1	0,1	60	1,2	
638/44	41	5	21/09/2017 11:40	NA	2	0,5	60	1,2	1	0,5	60	1,2	
639/45	42	6	21/09/2017 14:20	Design MG3	Not used	Not used	Not used	Not used	1	0,5	60	1,2	
640/46	43	7	21/09/2017 15:50	Design MG3	Not used	Not used	Not used	Not used	1	0,5	60	1,2	No catches
641/47	44	1	22/09/2017 6:50	Design MG3	Not used	Not used	Not used	Not used	1	0,5	60	1,2	
642/48	45	2	22/09/2017 8:07	Design MG3	Not used	Not used	Not used	Not used	1	0,5	60	1,2	
643/49	46	3	22/09/2017 9:30	Design MG3	Not used	Not used	Not used	Not used	1	0,5	60	1,2	
644/50	47	4	22/09/2017 10:50	Design MG3	Not used	Not used	Not used	Not used	1	0,5	60	1,2	
645/51	48	5	22/09/2017 12:06	Design MG3	Not used	Not used	Not used	Not used	1	0,5	60	1,2	
646/52	49	6	22/09/2017 13:35	Design MG3	Not used	Not used	Not used	Not used	1	0,5	60	1,2	
647/53	50	7	22/09/2017 15:23	Design SG2	Not used	Not used	Not used	Not used	1	0,5	60	1,2	
648/54	51	8	22/09/2017 16:49	Design SG2	Not used	Not used	Not used	Not used	1	0,5	60	1,2	

Station	Haul	Haul Day	Date	Gear	Lot	Pulse Duration	Amplitude	Electrode Length	Lot	Pulse Duration	Amplitude	Electrode Length	Comments
649/55	52	1	23/09/2017 7:55	Design SG3	Not used	Not used	Not used	Not used	1	0,5	60	1,2	UWR-No samples
650/56	53	2	23/09/2017 9:37	Design SG4	Not used	Not used	Not used	Not used	1	0,5	60	1,2	UWR-No samples
	54	NA	NA	NA	NA	NA	NA	NA	NA	NA	NA	NA	
651/57	55	3	23/09/2017 11:17	Design SG5	Not used	Not used	Not used	Not used	1	0,5	60	1,2	
652/58	56	4	23/09/2017 12:45	Design SG5	Not used	Not used	Not used	Not used	1	0,5	60	1,2	
653/59	59	5	23/09/2017 14:14	Design SG5	Not used	Not used	Not used	Not used	1	0,5	60	1,2	
654/60	60	6	23/09/2017 15:25	Design SG5	Not used	Not used	Not used	Not used	1	0,5	60	1,2	
655/61	61	1	24/09/2017 6:51	Design SG5	Not used	Not used	Not used	Not used	1	0,5	60	1,2	
656/62	62	2	24/09/2017 8:24	Design MG4	Not used	Not used	Not used	Not used	1	0,5	60	1,2	Not valid
657/63	63	3	24/09/2017 9:51	Design MG4	Not used	Not used	Not used	Not used	1	0,5	60	1,2	
658/64	64	4	24/09/2017 11:16	Design MG4	Not used	Not used	Not used	Not used	1	0,5	60	1,2	
659/65	65	5	24/09/2017 12:54	Design MG4	Not used	Not used	Not used	Not used	1	0,5	60	1,2	
660/66	66	6	24/09/2017 14:26	Design MG4	Not used	Not used	Not used	Not used	1	0,5	60	1,2	
661/67	67	7	24/09/2017 15:59	Design SG6	Not used	Not used	Not used	Not used	1	0,5	60	1,2	
662/68	68	1	25/09/2017 6:50	Design SG6	Not used	Not used	Not used	Not used	1	0,5	60	1,2	
663/69	69	2	25/09/2017 10:30	NA	1	0,5	60	1,2	1	0,5	40	1,2	
664/70	70	3	25/09/2017 11:45	NA	2	0,5	40	1,2	1	0,5	60	1,2	
665/71	71	4	25/09/2017 12:55	NA	2	0,5	60	1,2	1	0,5	40	1,2	
666/72	72	5	25/09/2017 14:05	NA	2	0,5	40	1,2	1	0,5	60	1,2	
667/73	73	6	25/09/2017 15:10	NA	2	0,5	60	1,2	1	0,5	80	1,2	
668/74	74	7	25/09/2017 16:20	NA	2	0,5	80	1,2	1	0,5	60	1,2	
669/75	75	1	26/09/2017 6:50	NA	2	0,5	80	1,2	1	0,5	60	1,2	
670/76	76	2	26/09/2017 7:55	NA	2	0,5	60	1,2	1	0,5	80	1,2	
671/77	77	3	26/09/2017 9:05	NA	2	0,5	60	1,2	1	0,5	60	1,2	
672/78	78	4	26/09/2017 10:15	NA	2	0,5	60	1,2	1	0,5	60	1,2	
673/79	79	5	26/09/2017 11:25	NA	2	0,1	60	1,2	1	0,5	60	1,2	
674/80	80	6	26/09/2017 12:30	NA	2	0,5	60	1,2	1	0,1	60	1,2	Whiting, not samp
675/81	81	7	26/09/2017 14:15	NA	2	0,5	60	1,2	1	0,5	60	1,2	Algae
676/82	82	8	27/09/2017 10:55	NA	2	0,5	60	1,2	1	0,1	60	1,2	
677/83	82	8	27/09/2017 12:25	NA	2	0,1	60	1,2	1	0,5	60	1,2	

Table 1: Description of hauls conducted during the second part of the cruise.

3.1 Development phase

3.1.1 Single-grid gear

Design SG1

This is the initial design brought onboard (Figure 9). During the first hauls of the cruise, it was observed that the gear tended to twist around its axis during towing, requiring several manoeuvres to be conducted by the deck-hand to achieve the correct orientation before being hauled-back. Only a very small fraction of the total shrimp catches were found in the escape cover, indicating very low sorting efficiency of this starting design. An additional problem was the clogging of catch before the guiding panel. All adjustment to address the mentioned problems were added to the design SG2.

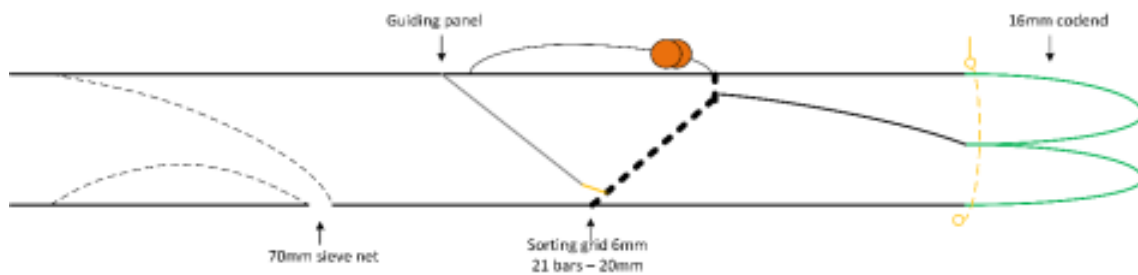

Figure 9: Details of Single-grid gear Design 1

Design SG2

Updates from design SG1:

- The buoys attached to the upper side of the grid were removed, as a strategy to avoid gear twisting during towing.
- The initial grid was replaced by an alternative grid with larger number of spaces between bars. This change should lead to an increase of water flow through the grid and therefore an improvement in the contact probability of shrimps with the grid.
- The guiding panel was untied to avoid clogging. However, it was not removed from the gear, so it could later be re-attached at a later stage if necessary.

SG2 (Figure 10) was the first design mounted in the pulse trawl.

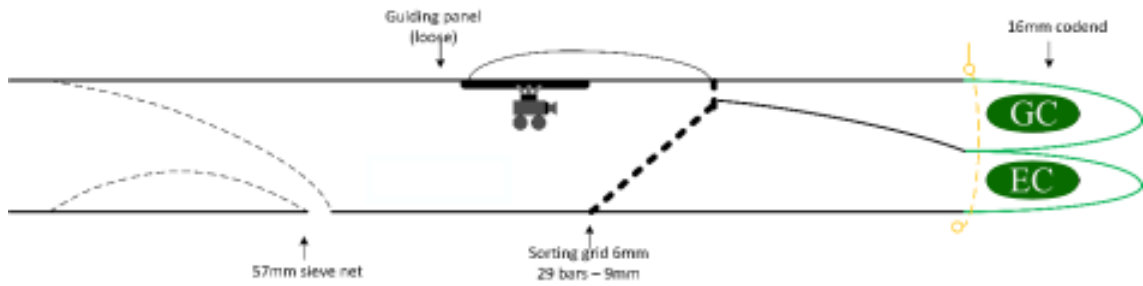

Figure 10: Details of design SG2. The green ellipses represent the two experimental compartments considered.

Design SG3

Updates from design SG2:

- Based on field observations, we assumed that the guiding panel was not responsible of the catch accumulation in front of the grid, therefore it was re-attached again. However, wider space was left between the ending tip of the panel and the floor of the gear (Figure 11).

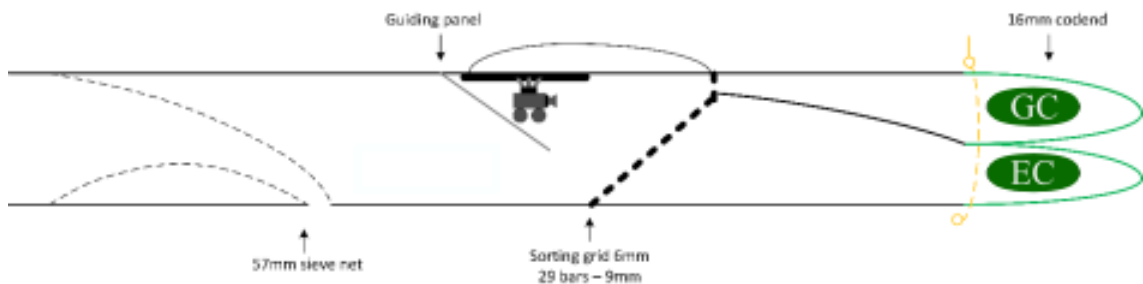

Figure 11: Details of design SG3

Underwater video recording on design SG3 showed the angle of attack of the grid to be far lower than the intended 45° . This unexpected configuration might facilitate the transportation of shrimps over the grid without an efficient contact to escaping zone between bars.

Design SG4

Updates from design SG3:

- Four small floats were attached to the frame of the grid in an attempt to increase the angle of attack (Figure 12).
- Some weights (~ 13 kg) were added to the bottom of the frame (Figure 12), to further reduce the probability gear twisting during towing (a problem already observed with design SG1).

A fraction of the catch sorted by the grid did not reach the aft of the covers. This is a problem systematically observed in the current and previous designs, which was addressed in design SG5.

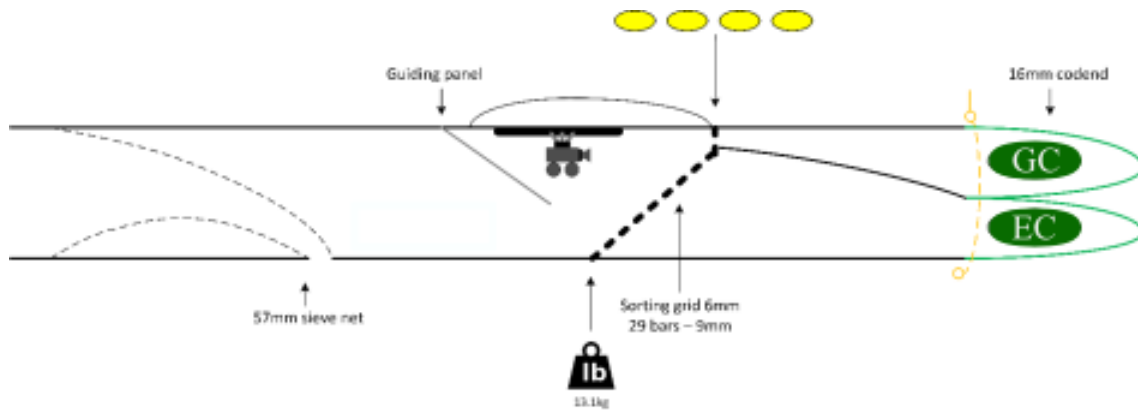

Figure 12: Details of design SG4

Design SG5

Updates from design SG4:

- The rope used to hang the gear and bring it on deck was initially located in a net section after the grid. The constriction of this rope might reduce the water flow through the covers, therefore reducing the transportation of the catches towards the aft of the gear. This rope was relocated and simply attached to the metal frame of the grid Figure 13.

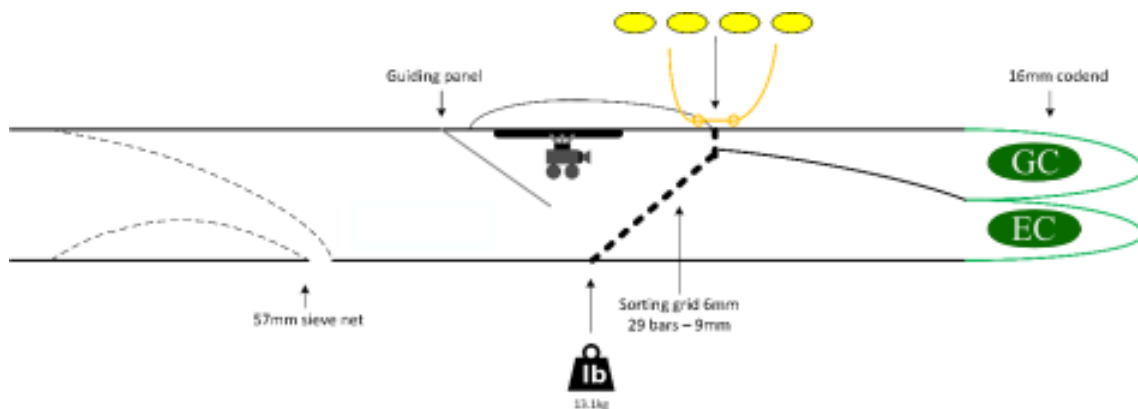

Figure 13: Details of design SG5

This simple solution apparently improved the sorting capacity of the design.

Design SG6

The final development introduced for the Single-grid gear was related to the guiding panel. Shrimp were going through the 20mm netting of the guiding panel and this panel was too loose to cleanly guide the catch to the grid. A 16mm part of netting was added to the 20mm guiding panel and this panel was more firmly attached (Figure 14).

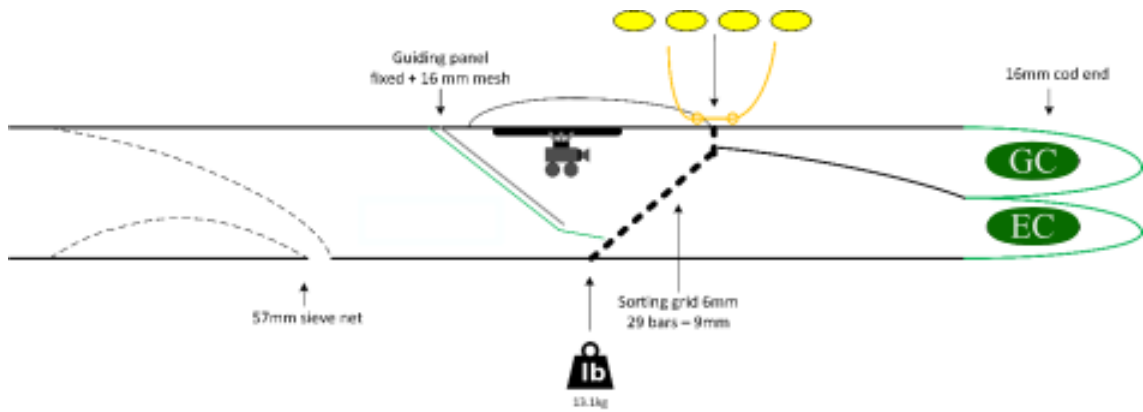

Figure 14: Details of design SG6

3.1.2 Multi-grid gear

Design MG1

This is the original design that was used during the start of the experiment. Due to the limiting time available for the initial tests, and to keep the workload manageable, it was decided to only fit the lower EC (Figure 15).

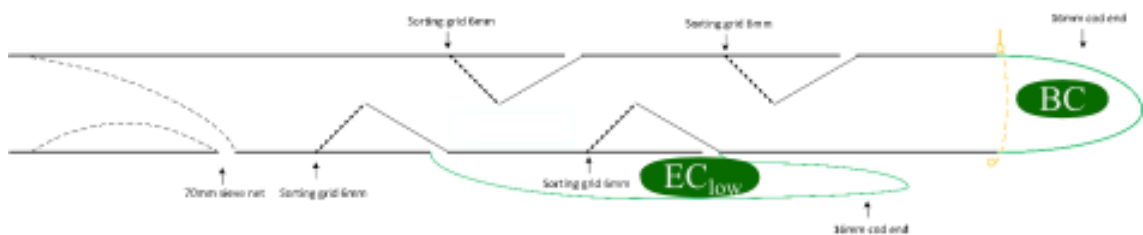

Figure 15: Details of Multi-grid design MG1

Design MG2

This and the successive designs were mounted to a pulse beam trawl. MG2 already used both the top and bottom EC's (Figure 16).

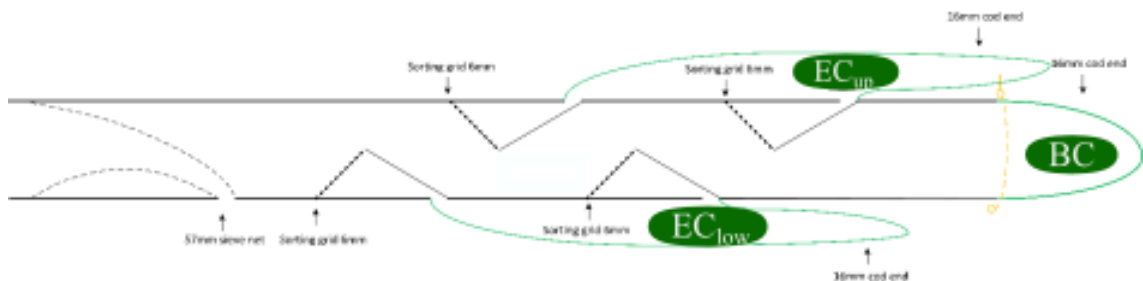

Figure 16: Details of Multi-grid gear design MG2

Design MG3

Field observation showed part of the catch tent to be found trapped between the grids. It was assumed that an improved water flow could potentially solve this issue. To address such issue, EC's were outfitted with floats (EC_{up}) and weights (EC_{low}) (Figure 17).



Figure 17: Details of Multi-grid gear design MG3

Design MG4

Very limited shrimps were found in the upper EC, indicating low contact probability to the upper grids, therefore it was decided to fold these two grids away in order to create a better water flow throughout the trawl. Water flow was still an issue because part of the catch bulk was found stacked in between the lower grids. To determine the functionality of the bottom grids separately they were fitted with individual covers ($EC1_{low}$ and $EC2_{low}$). Nevertheless during the tests of the improved design the water flow remained sub-optimal. (Figure 18).

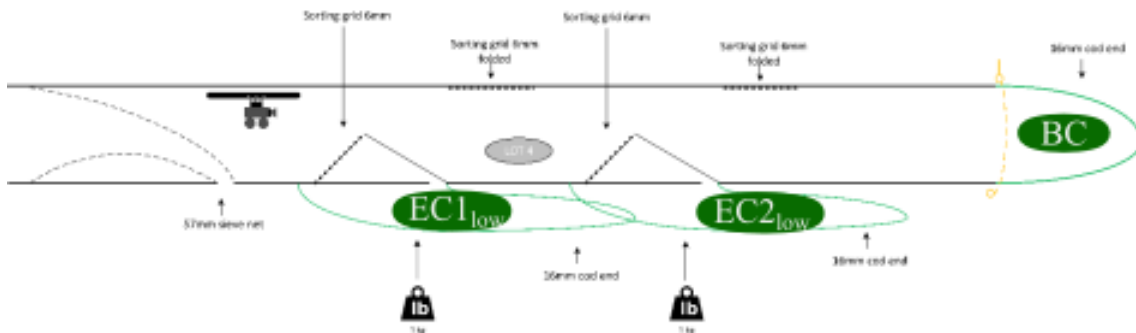

Figure 18: Details of Multi-grid gear design MG4

Design MG5

A final attempt to improve the water flow led to the removal of the netting behind the grids. Such nets were replaced by single strings woven back and forth (four times), between the two ends of the escape opening. This change aimed to hinder the water flow to a lesser extent. (Figure 19).

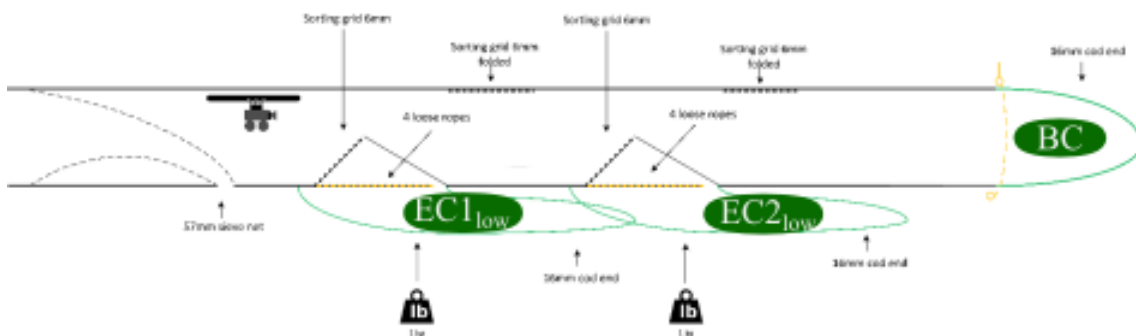

Figure 19: Details of Multi-grid gear design MG5

3.2 Analysis of sorting efficiency

The effort invested in the development process of both gears led to a large number of different designs established and tested (see previous sub-section). Due to the limiting time available, only a few number of hauls could be conducted for each design (Table 2). In particular, only the Single-grid design SG5 and the Multi-grid design MG3 accumulated sufficient number of sampled hauls enabling a quantitative assessment of their sorting efficiency on brown shrimp.

Haul	Date	Ground	Depth	Lat. start	Lon. start	Lat. end	Lon. end	Design	GC/BC	EC	EC_{low}	EC_{up}
42	21.09.17	Amrum Bank	15.30	54.57	8.07	54.61	8.11	MG3	30.21		4.50	0.77
44	21.09.17	Amrum Bank	14.80	54.67	8.14	54.72	8.14	MG3	26.81		3.68	0.35
45	21.09.17	Amrum Bank	13.50	54.75	8.17	54.80	8.16	MG3	66.22		4.14	0.68
46	21.09.17	Amrum Bank	14.80	54.82	8.15	54.77	8.14	MG3	16.16		2.40	0.13
47	22.09.17	Amrum Bank	12.30	54.80	8.16	54.75	8.16	MG3	13.16		2.07	0.17
48	22.09.17	Amrum Bank	12.20	54.74	8.15	54.74	8.06	MG3	7.86		0.40	0.02
49	22.09.17	Amrum Bank	12.80	54.74	8.03	54.71	7.95	MG3	5.16		0.49	0.00
50	22.09.17	Amrum Bank	15.90	54.70	7.91	54.66	7.87	SG2	4.55	1.72		
55	23.09.17	Amrum Bank	15.90	54.78	7.98	54.83	8.01	SG5	11.26	4.42		
56	23.09.17	Amrum Bank	13.10	54.83	8.01	54.78	7.98	SG5	5.89	0.81		
59	23.09.17	Amrum Bank	13.40	54.79	8.14	54.80	8.23	SG5	9.85	1.91		
60	23.09.17	Westlich Sylt	13.10	54.80	8.23	54.85	8.24	SG5	15.92	3.37		
61	24.09.17	Westlich Sylt	14.80	54.88	8.19	54.83	8.20	SG5	1.17	0.33		
63	24.09.17	Westlich Sylt	12.10	54.74	8.14	54.69	8.12	MG4	15.50		0.66	0.04
64	24.09.17	Amrum Bank	14.40	54.67	8.11	54.62	8.10	MG4	38.02		1.06	0.23
65	24.09.17	Amrum Bank	15.80	54.62	8.09	54.58	8.05	MG4	8.76		0.49	0.36
66	24.09.17	Amrum Bank	17.00	54.57	8.07	54.62	8.11	MG5	7.25		0.73	0.19
67	24.09.17	Amrum Bank	16.00	54.63	8.12	54.68	8.12	SG6	30.39	5.24		
68	25.09.17	Amrum Bank	13.70	54.72	8.13	54.67	8.11	SG6	3.52	0.69		

Table 2: Physical description of the experimental hauls conducted with the pulse trawls mounting the grid gears (second part of the cruise). Assessments of sorting efficiency was only possible for designs SG5 and MG3.

3.2.1 Single-grid SG5

A total of 5 valid hauls were conducted in two successive fishing days (4 hauls in 23.09. and 1 haul in 24.09., Table 2), however, only the first four hauls were used for the analysis, due to problems in the collection of brown shrimp length measurements for the haul conducted on the 24.09. Approximately 600 individuals per compartment and hauls were length-measured. Mean length obtained in GC was clearly larger than in EC, indicating a size selection process due to the presence of the grid (Table 3).

Four different sorting efficiency models varying in the size selection function used (see sub-section 2.4.1) were successfully applied to analyse the catch data. All the four models estimated very similar values for the selectivity parameters. Best fit was obtained by the model using the Richards size selection function (Table 4).

The sorting efficiency curve predicted by the best candidate model show good descriptive properties regarding the catch share of brown shrimp among GC and EC (Figure 20). The low selection range estimated [$SR = 3.43(2.74-5.23)$] shows that the size selection occurred within a very narrow range of lengths around the $L50 = 47.70(46.48-48.98)$ (Table 5). However, the model estimated that only around 50% [$C = 0.51(0.43-0.64)$] of brown shrimp entering in the grid zone were subjected to size selection.

Fishery Selectivity Indicators (Equation 8) were successfully estimated by applying the selectivity estimations from the best candidate model (Table 4), to the pooled catches aggregated over the experimental hauls (Table 4). The SG5 excluded around 40% of undersized brown shrimps who entered in the grid zone ($FSI_b = 60.12(50.10-69.10)$), being the losses of commercial sizes negligible ($\sim 1.5\%$) ($FSI_b = 98.37(96.97-99.33)$). Finally, by plugging the best candidate model results into the aggregated catch data, it was predicted that for every 11 brown shrimps entering in the codend, 4 individuals would be undersized ($nR = 57.37(44.97-71.35)$) Table 5.

Haul	Numbers sampled		Mean lengths	
	GC	EC	GC	EC
55	589 (0.089)	592 (0.226)	53.3 (34.5-68.5)	44.1 (34.5-56.5)
56	590 (0.170)	592 (1.000)	51.0 (31.5-64.5)	41.6 (30.5-56.5)
59	588 (0.102)	594 (0.525)	54.7 (36.5-70.5)	43.8 (34.5-58.5)
60	582 (0.063)	595 (0.297)	51.8 (32.5-66.5)	42.9 (32.5-60.5)

Table 3: Numbers of shrimp measured by haul and compartment (sampling rates in brackets) and mean length of shrimp obtained from the measurements (range of lengths in brackets)

Model	C	l50	sr	delta	deviance	p-value	AIC
CxRichard	0.51	47.70	3.42	0.52	136.64	> 0.01	21458.34
CxLogit	0.52	47.72	3.66		141.52	> 0.01	21463.23
CxGompertz	0.51	47.61	3.24		146.53	> 0.01	21468.22
CxProbit	0.53	47.65	4.20		190.19	> 0.01	21511.89

Table 4: Estimated selectivity parameters, fit statistics and AIC values from the four different candidate models. Table ordered by increasing AIC. First model (*CxRichard*) was selected for analyzing the experimental data

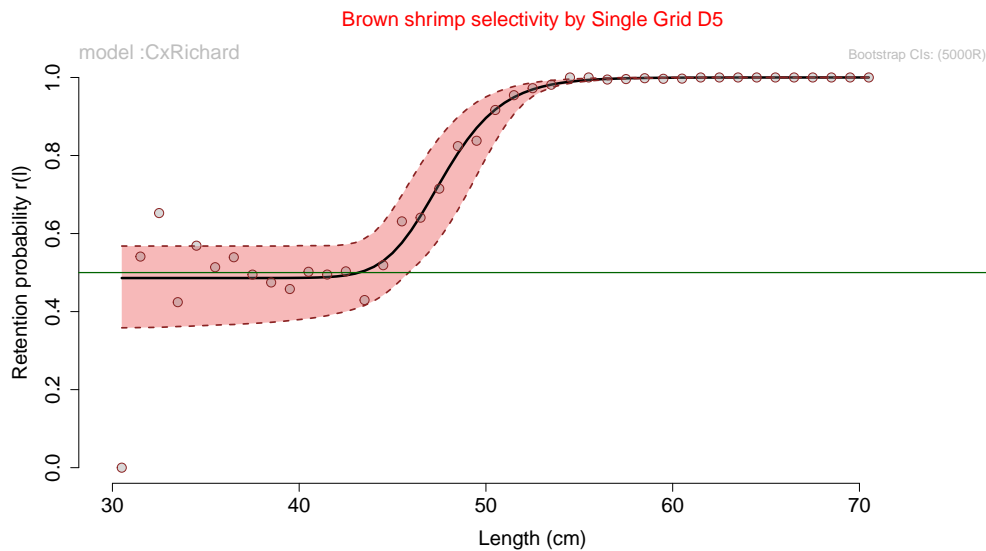

Figure 20: Average sorting efficiency curve and 95% bootstrap CL's estimated for design SG5 by the best candidate model. Points represent the proportion of catch of length l estimated in the GC.

	Parameter	Lower CL	Mean value	Upper CL
Selectivity parameters	C	0.43	0.51	0.64
	L50	46.48	47.70	48.98
	SR	2.74	3.42	5.23
Fishery Selectivity Indicators	FSI_a	96.97	98.37	99.33
	FSI_b	50.10	60.12	69.10
	FSI_t	74.07	79.85	84.29
	nR	44.97	57.37	71.35

Table 5: Average selectivity parameters from the best candidate model (*CxRichard*), Fishery Selectivity Indicators (FSI) and bootstrap CL's estimated for design SG5

3.2.2 Multi-grid MG3

A total of 8 valid hauls were conducted in two successive fishing days (2 hauls in 21.09 and 6 haul in 22.09) using the design MG3 (Table 2). One of the hauls conducted in the first day was used to assess the structural behaviour of the gear, and no catches were obtained for this haul. Therefore, only 7 hauls were used in the analysis Table 6.

In overall, Equation 7 described well the experimental catch sharing among compartments (Figure 21). However, it can be observed a systematic trend in the cloud of points relative to the fitted curves. In particular, most of the points representing lengths $\leq 30mm$ observed in the lower-grid compartment are systematically positioned above the related fitted curve, while the opposite happens for the upper-grid compartment (Figure 21). This trend might be result of either an unaccounted length-dependency in the contact probabilities (C1 and C2), or due to a certain size selection occurring in the EC and the BC . We assumed the second explanation to be the most likely, and therefore the results obtained by the model were considered valid to describe the catch sharing among compartments.

Being used the same bar-spacing, the L50 and SR parameters estimated by the model were similar to the SG5 grid system. In particular, the L50 was estimated around $1.5mm$ lower [$L50 = 45.09(40.44 - 46.34)$], while the selection range was found slightly ($> 1mm$) wider [$SR = 4.20(3.33 - 6.99)$]. Contact probability of brown shrimps with the either the Upper or Lower grids were estimated lower compared to the SG5 system. In particular, it was estimated that 32% of brown shrimps entering the gear contacted the any of the lower grids [$C1 = 0.32(0.25 - 0.58)$], while the contact probability with any of the upper grids was negligible [$C2 = 0.05(0.05 - 0.11)$] (Table 7).

Fishery Selectivity Indicators were successfully estimated by applying the selectivity estimations from the model to the pooled catches aggregated over the experimental hauls (Table 7) . The indicators show the lower efficiency achieved by the MG3 , in comparison with the previous SG5 design. Around 90% of shrimps entering the gear and being transported through the grids system ended in the codend (Codend Indicator $FSI_t = 88.20(84.60 - 91.10)$). Regarding the undersized shrimps, it should be expected that around 18% of individuals entering the gear could be released by the lower grids (Upper Grids Indicator $FSI_b = 17.60(14.10 - 22.50)$) ???. This indicator is reduced to a value of 3% in the case of the upper grid system [$FSI_b = 3.00(2.60 - 3.90)$]

3.3 Underwater video recordings

Overall the underwater video recordings were relevant material to understand the functioning of the gears and their problems. In particular, this material was used to assess

Haul	Numbers sampled			Mean lengths		
	Codend	Lower Grids	Upper Grids	Codend	Lower Grids	Upper Grids
42	589 (0.033)	595 (0.222)	596 (1.000)	48.6 (30.5-64.5)	39 (26.5-50.5)	40.5 (28.5-63.5)
44	587 (0.037)	598 (0.272)	460 (1.000)	50.1 (31.5-67.5)	41.6 (31.5-51.5)	43.9 (31.5-56.5)
45	594 (0.015)	599 (0.242)	599 (1.000)	52.6 (33.5-70.5)	43.8 (33.5-53.5)	44.1 (33.5-56.5)
46	586 (0.062)	598 (0.416)	0 (1.000)	47.2 (30.5-66.5)	41 (30.5-52.5)	NaN (NaN-NaN)
47	590 (0.076)	595 (0.484)	202 (0.995)	52.3 (35.5-69.5)	42.2 (32.5-57.5)	41.9 (32.5-50.5)
48	589 (0.127)	517 (1.000)	18 (1.000)	51.1 (35.5-63.5)	43.7 (35.5-52.5)	44.5 (36.5-51.5)
49	525 (0.194)	594 (1.000)	2 (1.000)	51.9 (34.5-66.5)	42.0 (34.5-53.5)	44 (41.5-46.5)

Table 6: Numbers of shrimp measured by haul and compartment (sampling rates in brackets) and mean length of shrimp obtained from the measurements (range of lengths in brackets)

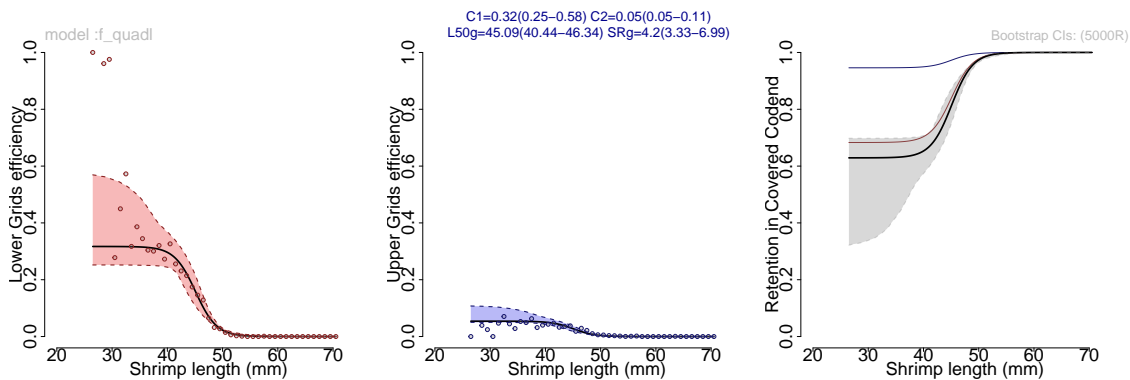

Figure 21: $p_{low}(l)$ (left), $p_{up}(l)$ (center) and global sorting efficiency (right) estimated for MG3 design

the functionality of the gears and the water flow, in order to identify which adjustments should be applied to increase sorting efficiency. Because of the turbidity of the North Sea waters, overcast weather conditions and a missing light source we were not able to obtain footages of the net on the ground. The dust plume created by the beam shoes, bobbins and ground rope make it impossible to record usable footage of the fishing process in action without manipulation of the gear. Therefore the material usable for tracking the gears performance were always taken when the net was retrieved and enough light would penetrate the water. From the camera angle in the Single-grid gear, it became clear that the guiding panel had an important function and needed a finer mesh to increase the water flow over the grid and guide nearly all shrimp over the grid. A 22 mm panel might have been too wide because the intention is to especially guide the smaller shrimp over the grid so they can be filtered out of the catch. In the MG design it became clearer that not all shrimp contacted the grid, especially the top grids saw a low contact rate. Additionally the eddy behind the initial grid could be seen as fish showed a greater capability to swim into the water flow behind the grids. The understanding of how these grids function and the related behavioural response of the animals could be greatly improved when it is possible to have footage of the actual fishing instead of when the net is close to the surface and hardly any sorting/fishing takes place any more. At this stage only the more mobile animals the the ones that were stuck to the netting previously can be seen passing the grid.

	Parameter	Lower Limit	Mean value	Upper Limit
Selectivity parameters	C_{low}	0.25	0.32	0.58
	C_{up}	0.05	0.05	0.11
	L50	40.44	45.09	46.34
	SR	3.33	4.20	6.99
Codend Indicators	FSI_a	99.10	99.60	99.70
	FSI_b	74.10	79.40	83.00
	FSI_t	84.60	88.20	91.10
Lower Grid Indicators	FSI_t	7.30	10.10	13.30
	FSI_a	0.30	0.40	0.70
	FSI_b	14.10	17.60	22.50
Upper Grid Indicators	FSI_t	1.40	1.70	2.40
	FSI_a	0.00	0.10	0.10
	FSI_b	2.60	3.00	3.90

Table 7: Average selectivity parameters and Fishery Selectivity Indicators (FSI) estimated for the for the Multi-grid Design 3 (MG3).



Figure 22: Whiting swimming in front of the Single-grid gear design 6. the net at the bottom of the image correspond to the guide panel covered with 16 mm netting (green meshes). The camera position can be checked in Figure 10

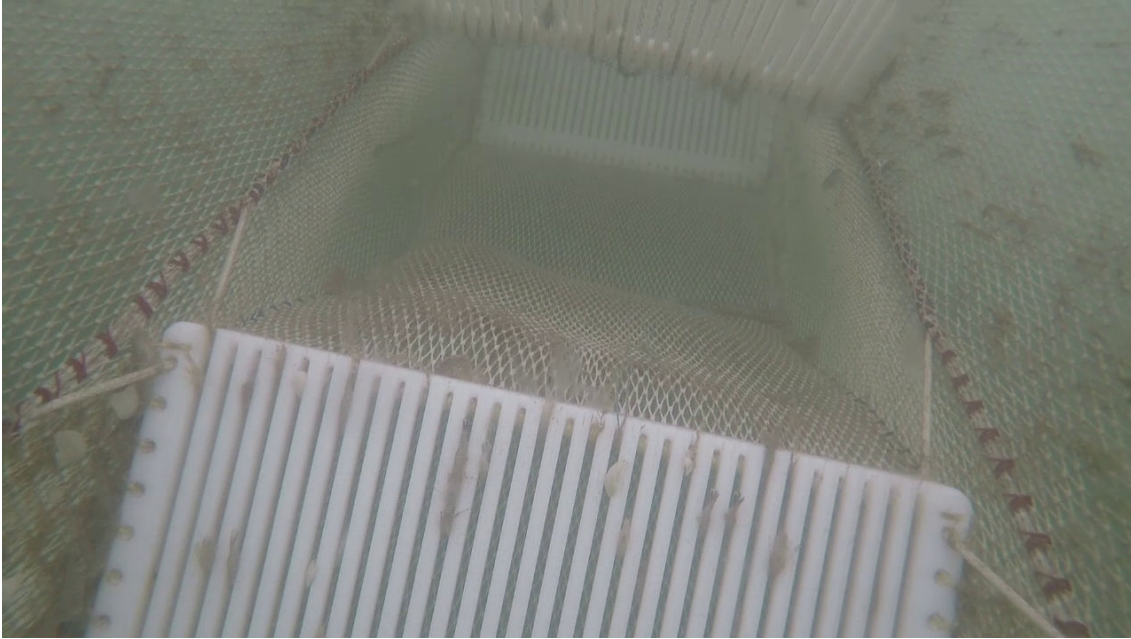

Figure 23: Top view of the front part of the multi-grid gear, showing the two upper grids and the front lower grid. The camera position can be checked in Figure 17

4 Final remarks

To our knowledge, this is the first time that plastic grids have been specifically applied as sorting device for brown shrimp in the North Sea. Two different grid-based gears have been proposed by the Dutch industry and tested in experimental conditions using a German Research vessel. Following the experience of the 2016 SOLEA Cruise SO725 conducted in 2016 [1], the present study is another good example of collaborative initiatives between Dutch and German stakeholders to address specific problems associated to North Sea fisheries, from a regional perspective.

Considering the sorting efficiencies successfully estimated in section 3.2, we conclude that the Single-grid gear is the most promising of the two concepts tested, specially when comparing the selectivity parameters L_{50} and SR obtained from the design SG5, with codend selectivity parameters predicted in CRANNET [8]. For example, the average L_{50} obtained for the SG5 was $L_{50} = 47.7mm$, a value comparable to the estimated L_{50} of a diamond-mesh codend of 27 mm mesh size ($L_{50} = 47.9mm$). In contrast, the Selection Range of the grid was significantly narrower than the range predicted for the 27mm codend ($SR = 3.4mm$ vs $SR = 10.1mm$). A narrow selection range reflects a sharper size selection around the L_{50} , which can lead to a significant reduction of undersized catches when the L_{50} is similar to the species minimum landing size, while keeping commercial catches.

The downside in the performance of the grid systems tested here was the relative low proportion of brown shrimps that contacted the escaping areas of the grids. In particular, it was estimated that only $\sim 50\%$ of brown shrimp entering the grid zone of the design SG5 made efficient contact with it, hence becoming available for size selection. Further investigations involving other designs and materials should be considered in order to make the selectivity of the grid available for the majority of shrimp individuals entering in the gear

No previous information was available at the beginning of the cruise on how the experimental gears should be rigged to ensure a correct mechanical and dynamic behaviour during towing, therefore, significant trial-error efforts were invested in order to identify and understand the different issues associated to their use. Bad weather conditions in the

first part of the cruise, and the large amounts of swimming crabs found in the catches (due to the inefficient sieve nets used) hampered the trials conducted in the first part of the cruise. Most of the gear developments presented here could be done only during the second part of the cruise.

Two main issues were identified during the tests: i) the gears tend to twist during towing and ii) Considerable amounts of catches entering the trawls got stuck in the tunnel before being sorted by the grids towards any of the established compartments. These two serious problems were mitigated by rigging solutions which were planned, implemented and tested *ad hoc* through the specification of successive gear designs. Future experiments should also consider a redesign of the gears (or specific components of them) in order to completely avoid these problems.

5 Research crew members

Beate Büttner	Technician	TI-OF)
Kees van Eekelen*	Fisherman	Visserijbedrijf Van Eekelen
Ina Hennings	Technician	TI-OF
Pieke Molenaar*	Researcher	Wageningen Marine Research
Jimmy van Rijn	Researcher	Wageningen Marine Research
Juan Santos*	Cruise Leader	TI-OF
Peter Schael	Technician	TI-OF
Kerstin Schöps*	Technician	TI-OF
Daniel Stepputtis**	Cruise Leader	TI-OF

(*) First half of the cruise, (**) Second half of the cruise

6 Financial contributions

The present research cruise was financed by the German Government. In addition, the Dutch scientific contribution was funded by the Ministerie van Economische Zaken, and Dutch industry participation was funded by the Nederlandse Vissersbond with the European Maritime and Fisheries Fund (EMFF) project Netinnovatie Kottervisserij deel 2.

7 Acknowledgments

The research crew thank the FFS SOLEA crew for the flexibility they showed to adapt their work to our experimental design. Their active involvement in the research contributed significantly to end the cruise with success. We also thank the support provided by our colleagues on land: Bernd Mieske and Annemarie Schütz . Thanks to the Dutch ministry of EZ and the Nederlandse Vissersbond for funding the construction of the experimental gears.

References

- [1] Bericht über die 725. reise des ffs solea vom 07.09 bis 23.09.2016. thuenen-institut für ostseefischerei. https://literatur.thuenen.de/digbib_extern/dn058687.pdf. FL: Juan Santos.
- [2] The north sea brown shrimp fisheries. <http://www.europarl.europa.eu/studies>. Directorate-General for Internal Policies, European Parliament; 2011.
- [3] Optimierte netz-steerte für eine ökologisch und ökonomisch nachhaltige garnelenfischerei in der nordsee (crannet). https://www.thuenen.de/media/institute/sf/Projektdateien/468/CRANNET_Abschlussbericht.pdf.
- [4] T.L. Catchpole, A.S. Revill, J. Innes, and S. Pascoe. Evaluating the efficacy of technical measures: a case study of selection device legislation in the uk crangon crangon (brown shrimp) fishery. *ICES Journal of Marine Science*, 65(2):267–275, 2008.
- [5] M. Hufnagl and A. Temming. Growth in the brown shrimp crangon crangon. ii. meta-analysis and modelling. *Marine Ecology Progress Series*, 435:155–172, 2011.
- [6] T. Neudecker and U. Damm. The by-catch situation in german brown shrimp (crangon crangon l.) fisheries with particular reference to plaice (*pleuronectes platessa l.*). *Journal of Applied Ichthyology*, 26:67–74, 2010.
- [7] A. Revill and R. Holst. The selective properties of some sieve nets. *Fisheries Research*, 66(2-3):171–183, 2004.
- [8] J. Santos, B. Herrmann, D. Stepputtis, C. Günther, B. Limmer, B. Mieske, S. Schultz, T. Neudecker, A. Temming, M. Hufnagl, et al. Predictive framework for codend size selection of brown shrimp (crangon crangon) in the north sea beam-trawl fishery. *PloS one*, 13(7):e0200464, 2018.
- [9] I. Tulp, C. Chen, H. Haslob, K. Schulte, V. Siegel, J. Steenbergen, A. Temming, and M. Hufnagl. Annual brown shrimp (crangon crangon) biomass production in northwestern europe contrasted to annual landings. *ICES Journal of Marine Science*, 73(10):2539–2551, 2016.
- [10] D. Valentinsson and M. Ulmestrand. Species-selective nephrops trawling: Swedish grid experiments. *Fisheries Research*, 90(1):109–117, 2008.
- [11] D.A. Wileman. Manual of methods of measuring the selectivity of towed fishing gears. *ICES cooperative research report*, 215:38–99, 1996.